

Head

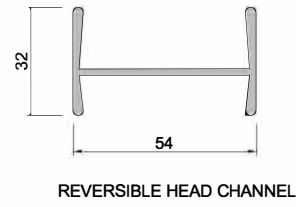

REVERSIBLE HEAD CHANNEL

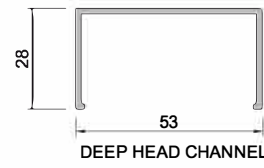

DEEP HEAD CHANNEL

Post

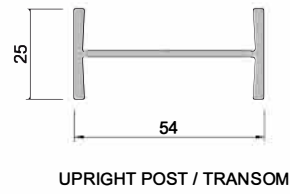

UPRIGHT POST / TRANSOM

O Post

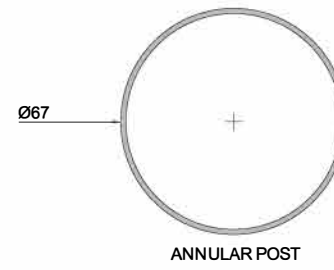

ANNULAR POST

Heavy Capping

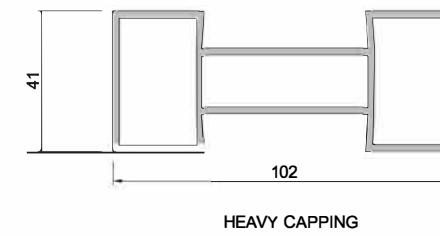

HEAVY CAPPING

Door Frame

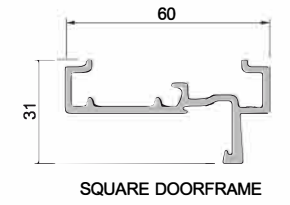

SQUARE DOORFRAME

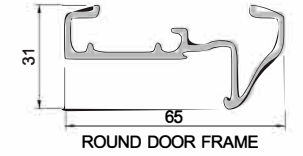

ROUND DOOR FRAME

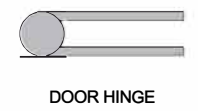

DOOR HINGE



DOOR SEAL

Junction Posts

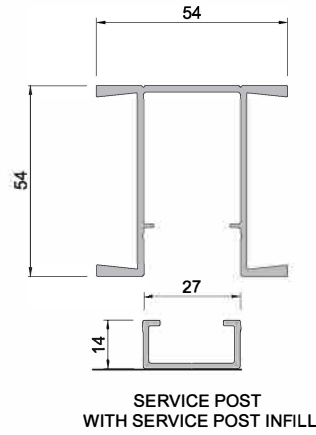

SERVICE POST WITH SERVICE POST INFILL

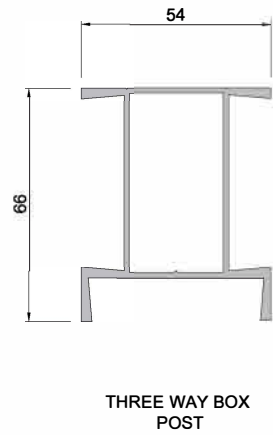

THREE WAY BOX POST

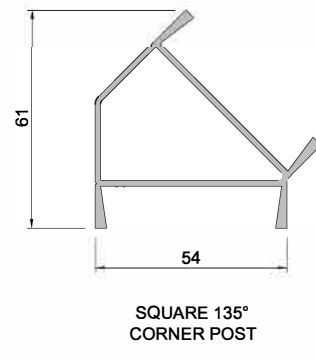

SQUARE 135° CORNER POST

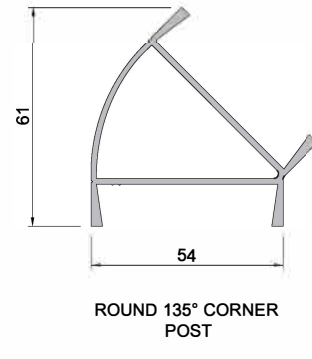

ROUND 135° CORNER POST

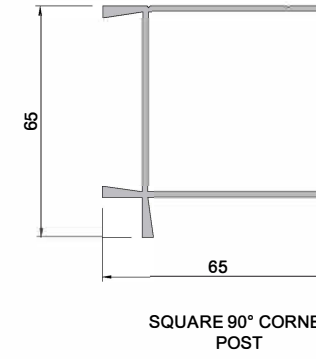

SQUARE 90° CORNER POST

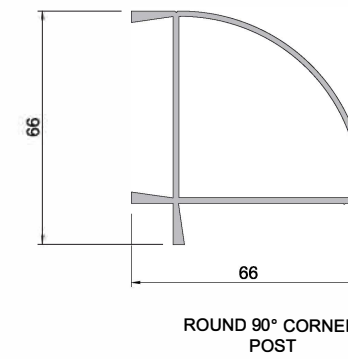

ROUND 90° CORNER POST

Glazing Profiles

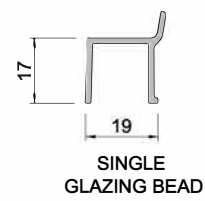

SINGLE GLAZING BEAD

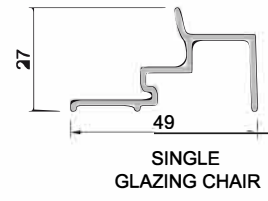

SINGLE GLAZING CHAIR

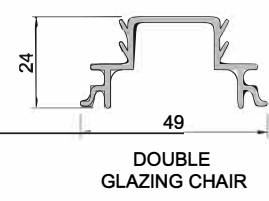

DOUBLE GLAZING CHAIR

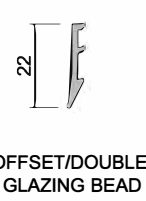

OFFSET/DOUBLE GLAZING BEAD

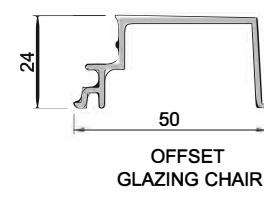

OFFSET GLAZING CHAIR

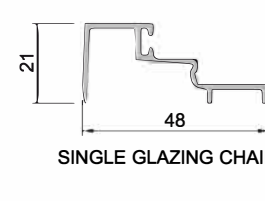

SINGLE GLAZING CHAIR



FLIPPER SEAL

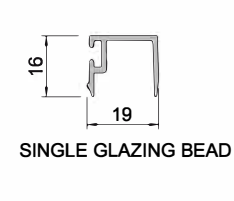

SINGLE GLAZING BEAD

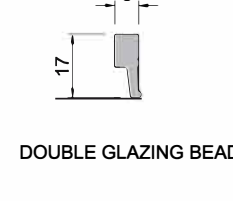

DOUBLE GLAZING BEAD

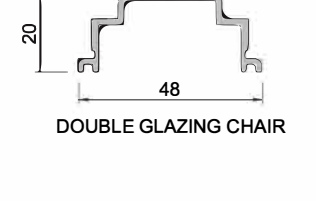

DOUBLE GLAZING CHAIR

Base

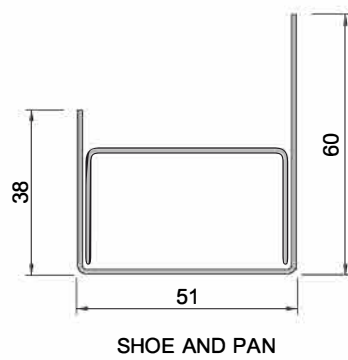

SHOE AND PAN

Skirting

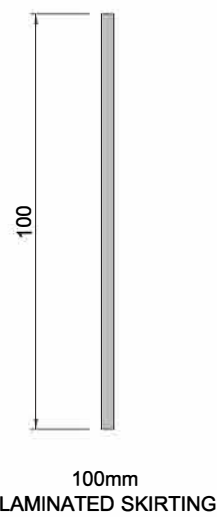

100mm LAMINATED SKIRTING

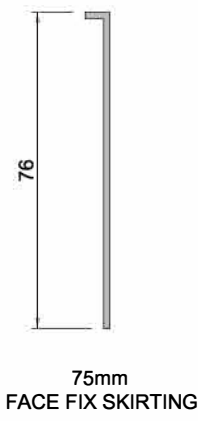

75mm FACE FIX SKIRTING

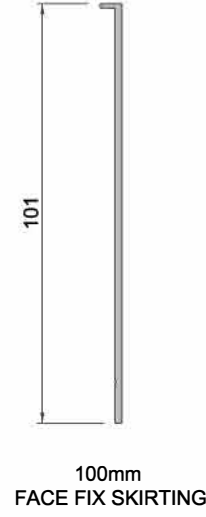

100mm FACE FIX SKIRTING

Abutment

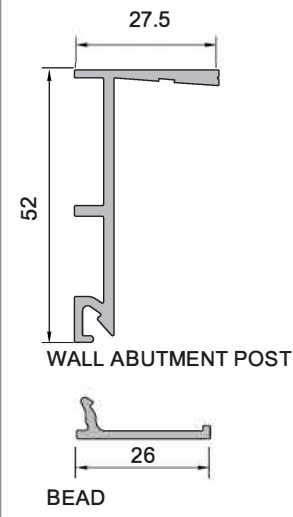

WALL ABUTMENT POST

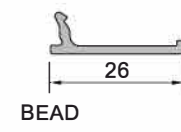

BEAD

Other Sections

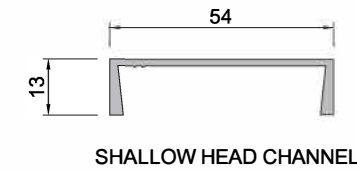

SHALLOW HEAD CHANNEL

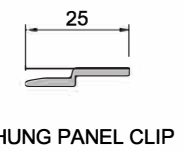

HUNG PANEL CLIP

Infill

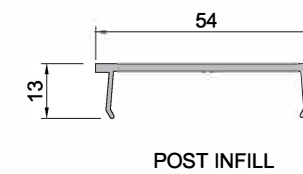

POST INFILL

**SEKTOR 50
PROFILES CHART**

SEKTOR